

83.

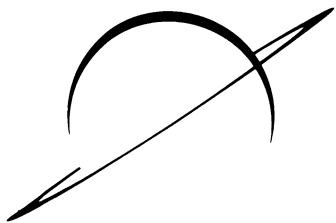

ZANUSSI

**Instructions
for the use and care
of ZE 942 cooker**

Contents

Instructions for the owner

Installation	Page 3
Technical data	Page 3
Use	Page 4
Electric oven	Page 6
Digital electric programmer	Page 8
Using the programmer.	Page 8
Cooking procedure	Page 12
Maintenance & cleaning	Page 14

Instructions for the installer

Installation	Page 16
Electrical connection	Page 18
Maintenance.	Page 19

Caution

Before you start operating the appliance, be sure to remove the plastic films protecting the stainless steel or anodized aluminium parts.

Important: During normal cooking operations the appliance will get very hot. Therefore, do not let children play near the appliance.

Instructions for the owner

Installation

It is mandatory that all operations required for the installation, the adjustments, the conversion to the type of gas available etc. be carried out by QUALIFIED PERSONNEL in accordance with existing rules and regulations.

The relevant instructions are to be found in the special chapter for the installer.

This appliance meets the requirements laid down in EEC Directive No 76/889 dated 4/11/1976 relating to the suppression of radio and TV interference.

Technical Features

Dimensions: width		mm 900
depth		mm 598
height		mm 597
Oven volume		dm ³ 52,5
Cooking programmer DIEHL		h 12
Hob*: Front left dia.	mm. 180	W 1500
Back left dia.	mm. 145	W 1000
Back right dia.	mm. 180	W 1500
Front right dia.	mm. 145	W 1000
Maximum Power Absorbed:		kW 5,0
Oven: Oven heating element		kW 2,5
Removable grill		kW 2,0
Oven lamp		W 15
Maximum power absorbed		kW 2,515
Power Supply: 50 Hz		V 240
Total power:		kW 7,515

(* The front left heating element is automatically switched on or off by means of the electric programmer.

Use and care

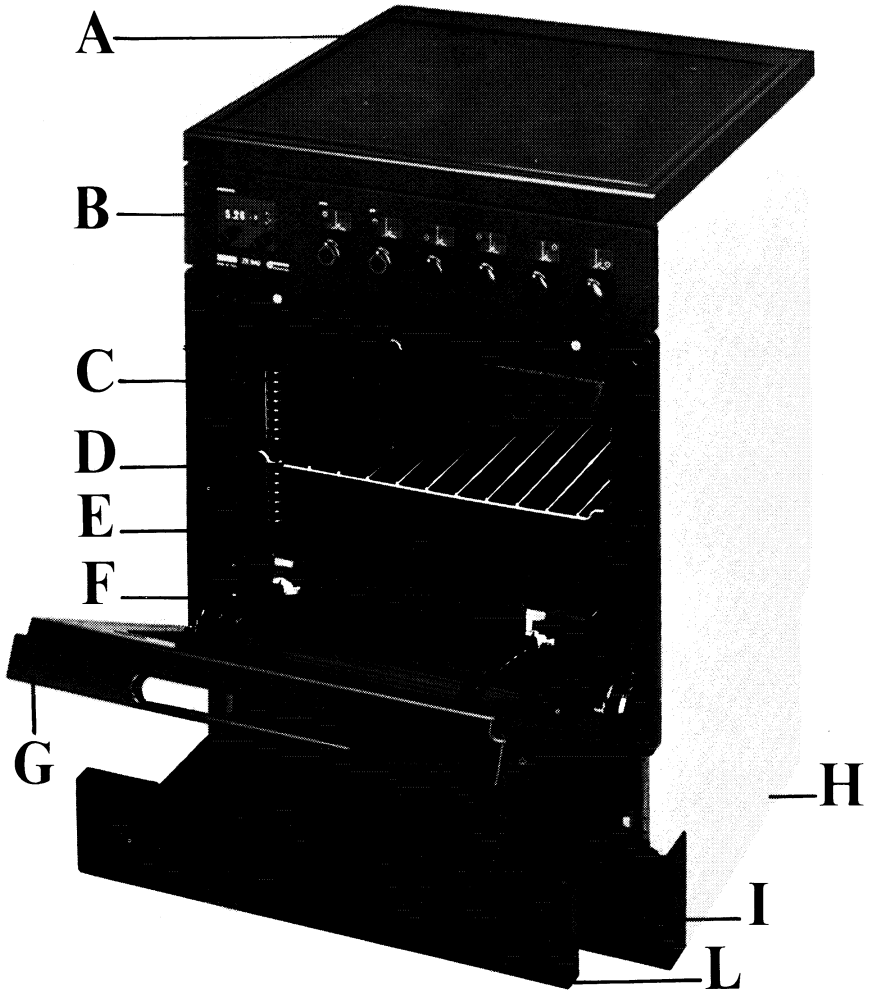

A - Ceramic hob
B - Control panel
C - Side grilles
D - Grilles
E - Dripping pan

F - Handle
G - Oven door
H - Removable base
I - Front panel
L - Removable drawer

Control panel

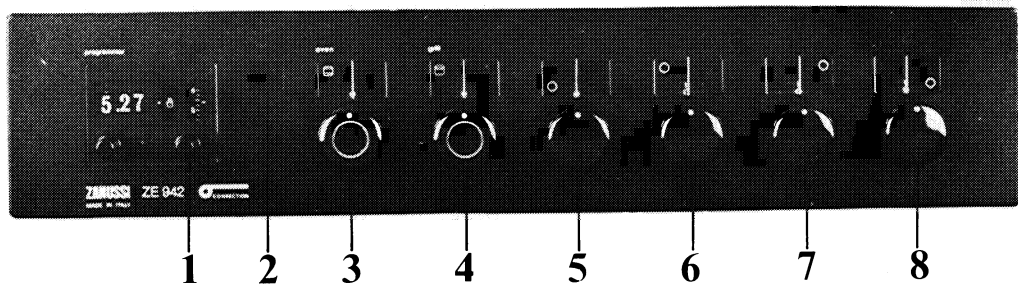

1. Programmer
2. Thermostat light
3. Oven knob
4. Grill knob
5. Front left heat zone control knob
6. Back left heat zone control knob
7. Back right heat zone control knob
8. Front right heat zone control knob

Oven

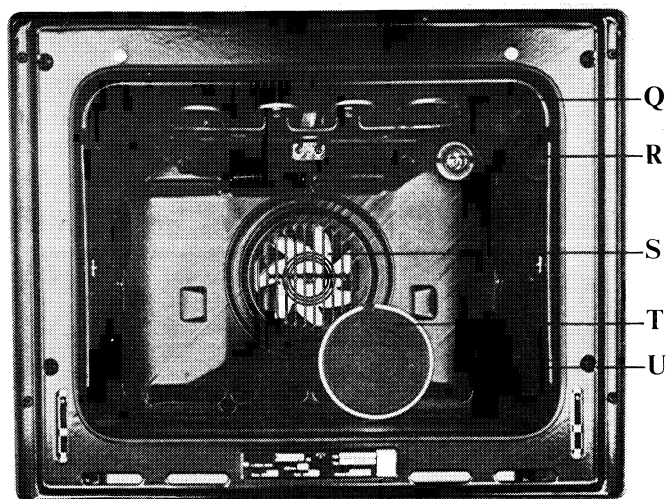

- Q** - Removable grill
- R** - Oven light
- S** - Fan
- T** - Filter
- U** - Enamelled panels

Operation

Ceramic-glass hob

This hob consists in a perfectly flat surface, made of a special material resistant to high temperatures and to shocks.

The heating elements are placed under the ceramic-glass surface, in contact with it, directly underneath the silk-screened areas on the hob itself.

This surface, which is perfectly flat, avoids any risk of the saucepans being upset; furthermore it allows use of the areas adjoining the heat sources as dish warmer areas.

Important: Be very careful when frying food in hot oil or fat as the overheated splashes could easily flare up.

Electric oven

The oven is evenly heated throughout. A fan in the back wall distributes heated air round the food during cooking so that everything cooks in the same time regardless of where it is placed in the oven or how much is being cooked.

Foods of different types, provided they require the same cooking temperature, can be cooked together and there is no possibility of any flavours or smells being transmitted from one food to another.

The oven has a removable grill.

Cooking by either oven or grill can be manual or automatic (without or with the programmer). This includes a digital clock, a minute minder and controls by which the oven can be set to come on and go off unattended.

Indicator light on the control panel shows the behaviour of the thermostat during cooking.

A light comes on inside the oven when it is switched on and remains on until the oven goes off.

The grill cannot be used at the same time as the oven.

The grill control provides a variety of heat settings.

Control Knobs

On the control panel of the oven there are the knobs for the operation of the four ceramic-glass heating elements.

Programmed heating element (Fig.1)

The front left heating element can be programmed to switch on and off automatically at a preset cooking time; the operations for the programming are quoted in the paragraph "Electric programmer".

The knob has 7 settings.

The selected temperature is kept constant through a temperature feeler which automatically turns the respective heating element on and off as required.

When set on "max.", the temperature feeler is cut out and, consequently, the relevant heating element remains turned on at peak power.

Figure 1

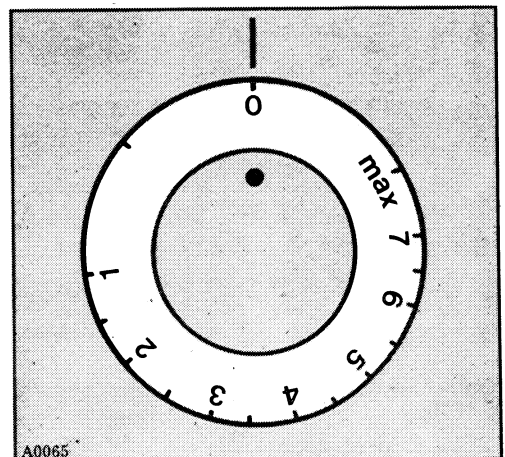

A0065

Using the oven

As soon as the oven is switched on the fan starts and runs until the oven control is switched off again (fig.2).

The food should be put into the oven before switching on, even when cooking manually- the speed of heating up is so fast that there is no need to preheat. The oven shelves can be fully filled. Most normal types and materials of cooking utensils can be used.

During cooking the door should be opened as little as possible to avoid heat loss and so excessive electricity consumption.

Cooking manually

When cooking manually ensure that the programmer is not in operation accidentally.

Arrange the food in the oven, shut the door and turn the oven control (See Fig. 2) to the required temperature setting.

When the knob is set to ☼ the oven temperature light will come on, also an internal oven light.

This setting is NOT a cooking position but is intended for rapid thawing of frozen food.

Positions from 50 °C to MAX are cooking positions and give a full range of temperatures. The oven temperature light will come on until the oven has reached the correct temperature; after that it will come on and off showing how the temperature is being maintained.

Cooking automatically

The oven or grill can cook automatically when the programmer is set to switch it on and off at the times given without the need for anyone to be in attendance.

Most foods cook well automatically but preference should be given to those which will not be affected by the waiting period before the oven comes on.

Figure 2

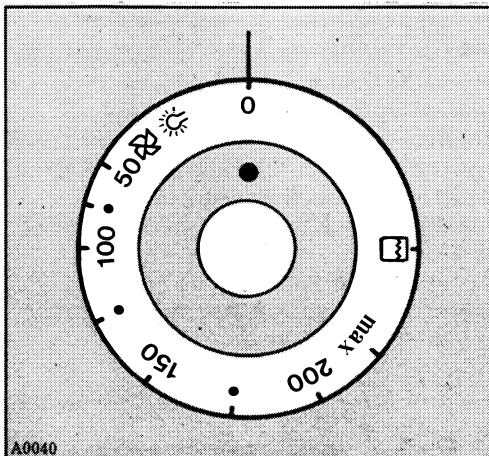

A0040

Automatic timer

The automatic timer makes it possible for the oven and/or front left hot plate/heat area to be turned on and off automatically at the pre-set time. Furthermore, the timer will show the time of the day and will also ring a bell at the end of the cooking cycle.



Operating the automatic timer

The figure 3 shows the control knobs of the automatic timer. With knobs 1,2 and 3 you can carry out all required adjustments, as described hereunder.

Knob 1

By turning this knob clockwise, you can set the timer to the correct time or reset it after a power failure.

Knob 2

By turning this knob clockwise, you can set the following functions on dial 4:
Cooking duration (210 mins. max.);
Stopping the ringing bell (position );
Manual operation of the oven and/or hot plate/heat area (position ).

Knob 3

By depressing and turning this knob clockwise as well as anticlockwise, you can set the cooking start time on dial 5.

Attention:

When setting the timer to the correct time of the day, make sure that both the electric clock and dial 5 actually show the same time.

Manual operation

The oven and/or hot plate/heat area can also be operated manually .
Turn knob 2 clockwise until the symbol  coincides with the index of dial 4.

Semi-automatic operation

1st alternative:

Start cooking immediately through manual operation; end of cooking through the timer.

Place the food to be cooked in the oven and/or on the hot plate/heat area.
Turn knob 2 clockwise and set the cooking duration on dial 4.

Turn the thermostat knob and/or the hot plate/heat area knob, respectively, to the required temperature.

2nd alternative:

Cooking start through the timer;
End of cooking through manual operation.
Place the food to be cooked in the oven and/or on the hot plate/heat area.



Depress knob 3 and turn it clockwise until the cooking start time appears on dial 5.
Turn knob 2 clockwise and set the maximum cooking duration (210 mins) on dial 4.

Turn the thermostat knob and/or the hot plate/heat area knob, respectively, to the required temperature.

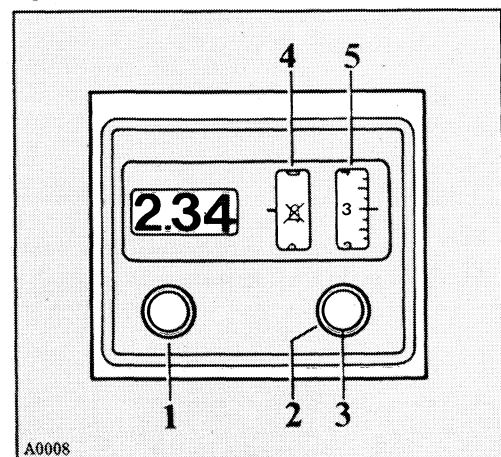
Figure 3



Important:

When the cooking time has elapsed, turn knob 2 clockwise until the "0" coincides with the index on dial 4. Then turn the control knob to  or . Turn the thermostat knob and/or hot plate/heat area knob to "0".

Fully automatic operation

Place the food to be cooked in the oven and/or on the hot plate/heat area. Turn knob 2 clockwise and set the required cooking time (max. 210 mins) on dial 4. Depress knob 3 and turn it clockwise until the cooking start time appears on dial 5.

Turn the thermostat knob and/or the hot plate/heat area knob to the required temperature.

After completion of the cooking cycle, the symbol "0" will coincide with the index on dial 4. On this setting, the oven and/or hot plate/heat area are electrically turned off.

Furthermore, the buzzer reminds you that the cooking cycle is completed.

To turn off the buzzer, turn knob 2 clockwise until the symbol  coincides with the index on dial 4.

How to use the automatic timer

Cooking end time: 19,00 hours;
Cooking duration: 2 hours (120 mins).
Place the food to be cooked in the oven and/or on the hot plate/heat area.

Turn knob 2 clockwise and set the cooking duration (120 mins.) on dial 4. Depress knob 3 and turn it until you set on dial 5 the cooking start time (5 o'clock = 17,00 hours).

Turn the thermostat knob and/or the hot plate/heat area knob to the required temperature.

After this, the oven and/or hot plate/heat area will automatically turn on at 17,00 hours and then at 19,00 hours after completion of the cooking cycle.

Minute minder

Turn knob 2 clockwise and set the selected time (max. 210 mins.) on dial 4. To turn off the buzzer, turn knob 2 until the symbol  coincides with the index of dial 4.

Note:

There is no difference between automatic cooking and normal cooking inasmuch as the function of the automatic timer is to control the selected cooking time while you are absent or engaged in other activities.

Therefore, completely automatic cooking is most suitable for foods or dishes that require no special care.

The cooking start time can be pre-set up to a maximum of 12 hours in advance.

Using the grill

As with the oven the grill control (see Fig.4) can be set to a number of different heat settings.

At MAX the thermostat controlling the heat does not operate and the element stays on continuously to give the highest heat possible.

Foods to be grilled are placed on the wire grid in the grill pan, which can be curved either upwards or downwards to give the required distance from the element.

The pan is then put into the third runner position, counting from the bottom of the oven upwards.

Figure 4

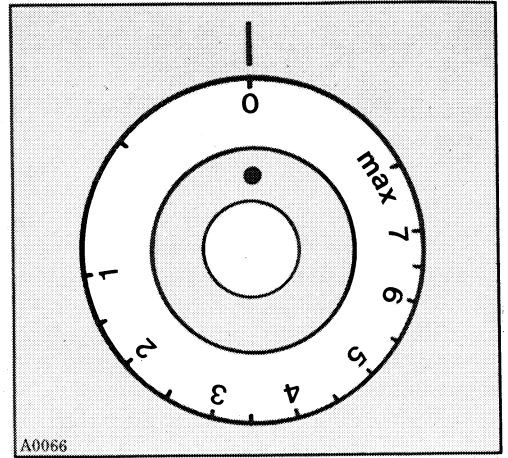
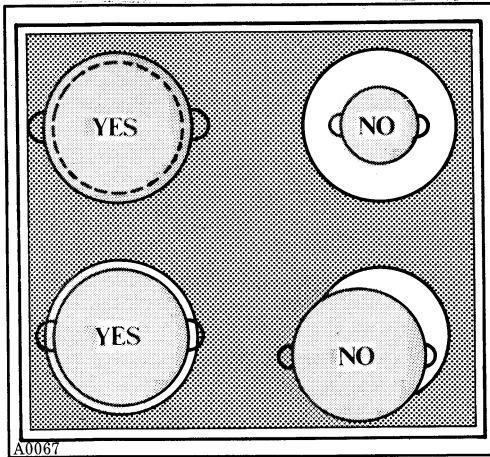

Figure 5



Useful hints for the use of ceramic-glass hob

The max. efficiency and the maximum service life of the appliance is obtained by using it correctly.

The most important characteristic of the special glass-ceramic surface is to transmit vertically all the heat of the underneath heating element, without vertical loss of heat.

In this way it is possible to make use of the all supplied power and to have the areas adjoining the cooking areas with a lower temperature.

The maximum efficiency, that is the complete and quick heat transmission from the hob to the pans is obtained by using flat bottom pans.

To avoid useless energy consumption, we suggest you to use aluminium and steel pots and pans with perfectly flat bottom (Fig.5).

The four cooking areas on which pots and pans must be put, are indicated on the ceramic-glass surface with circular lines. To obtain the maximum hob efficiency, it is strongly recommended that pots and pans are perfectly placed within the circumscribed cooking areas (Fig.6).

However, you can use pans and pots with slightly superior diameter than the heating areas, but we suggest not to use pans and pots with a smaller diameter.

Important:

When you are using the hob be careful to avoid objects (i.e. pans, pots) falling or being dropped on the hob.

In no case the hob must be used with aluminium foil in contact with its surface. The hob surface should not be used as cooking surface without vessels.

Figure 6

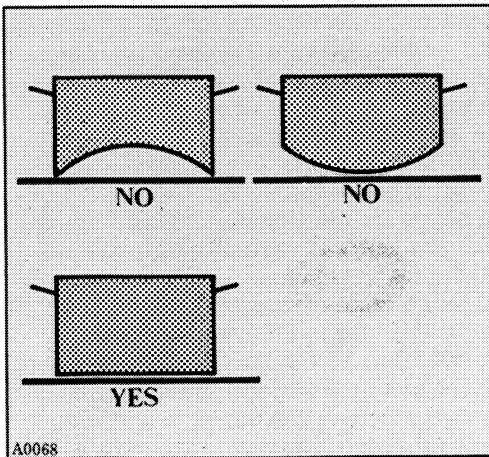

Cooking possibilities on the ceramic hob

Any kind of cooking operations can be easily carried out on the ceramic hob. Obviously, the complete knowledge and the appreciation of the infinite cooking possibilities of the hob will be possible only by using it and by checking out the results of the first cooking operations.

Safety thermostat

The safety thermostat placed inside each heating element, prevents possible overheatings caused by a wrong use of the hob (e.g. operation without pots, or use of not suitable pots or incorrectly positioned).

Hints for a correct use of the oven and the grill

The oven wire grid can be curved either upwards or downwards to give the required distance from the heating elements.

Whipped up kneadings have the required firmness when they tend to stick to the spoon as, otherwise, an excessive fluidity would uselessly stretch the cooking time. Shortbread kneadings should first be baked in the mould on the baking-tin for about two-thirds of the total baking time, and then be garnished (trimmed) before you complete the baking.

This final baking time depends on the type and quantity of the garniture (trimmings). Gourmets greatly appreciate grilled food as it usually remains very tender and savoury. All meats are suitable for grilling, with the exception of some lean game meats and meat-loaves.

The meat must be thoroughly drained, i.e. kept until it becomes high (tender). The pieces of meat to be cooked should not weigh less than 1 Kg. boneless. If bones are removed beforehand, this will shorten the cooking time and it will be easier to cut the meat.

Meat needs to be turned over only if cooking is done at higher temperatures. Ingredients for the gravy should be placed in the baking-tin straightaway if cooking is to be short. If cooking is to last long, instead, these ingredients are to be added during the last half-hour.

To find out if the meat is done, press it down with a spoon.

If it is well done the meat should not give in (yield). When the meat is done to a turn, the gravy is grayish in colour. Cooking time for roast-beef and fillet, the inside of which should remain of a pink colour, is reduced.

Wait for at least 15 minutes before cutting the meat, so that the dish gravy (meat juice) may settle down instead of dripping out profusely.

The dish can be kept warm in the oven with the thermostat turned off.

To use the grill

Open the door and put the heat deflector in position.

Turn the oven control (Fig. 2) to  and then set the grill control to the heat setting required.

A little use and practice will soon show which heat setting is the best for the individual user.

When grilling is over remove the heat deflector and shut the door.

Safety thermostat

This device cuts out the electricity supply in case of failure of the temperature control, and thus prevents the hazard of overheatings.

The thermostat switches on again automatically as a result of a decrease in temperature.

If the safety thermostat cuts in due to a faulty component, contact your local Dealer.

Cleaning

After every meat roasting wipe the oven panels with a damp cloth as soon as they have cooled so that any fat splashes are removed.

After use wipe over the rest of the oven with a cloth wrung out in liquid detergent. Do not use abrasive scourers or steel wool on any stainless steel or painted surfaces. Always wait until the oven is cool before cleaning- this is particularly important where the glass oven door is concerned. From time to time it will be necessary to do a more thorough cleaning.

When the operations described below are carried out the oven should first be unplugged or switched off from the electricity supply.

To remove the grease filter

This filter protects the fan from fat splashes; it should always be cleaned after roasting has taken place.

As it is stainless steel you can safely wash it in a dishwasher.

Upkeeping and cleaning

Important: before undertaking any cleaning or upkeeping operation, be sure to have the appliance disconnected from the electric supply.

For a long service life of the appliance, we strongly recommend that you frequently carry out a thorough cleaning operation.

The hob cleaning operations can be easily done by using a damp cloth or one of the normal products available on the market (never use coarse or abrasive products).

Possible deposits and residual soil can be removed by using a wool scraper; never use sharpened or pointed tools.

Particularly persistent deposits (e.g. burnt milk) can be cleaned up when the hob is slightly warm. It is easy to get rid of calcareous residues by using some vinegar.

The hob frame, after each use, should be carefully rinsed with water and then dried with a clean soft cloth or chamois leather.

Never use steel-wool pads, muriatic acid or similar products which might scratch, engrave, grind etc.

Important: if a plastic object accidentally falls down on the hob whilst hot, it is necessary to remove the object and its main residues immediately.

When the hob has cooled, the remaining residues can be removed.

Unless the above cleaning operation is done, removing soil residues, when the hob is cool, would be very difficult.

Caution: If scoring or cracks on the hob ceramic surface are found it will be immediately advisable to turn the appliance off and to call your local Zanussi Network centre.

Cleaning the oven

Always wait until the oven is cool before cleaning.

All enamelled parts should be washed with lukewarm water and detergent without using abrasive products which might damage them.

The oven should be cleaned inside with the greatest care, after each use, with hot water and detergent (or one of the special products available on the market).

When cleaning the oven, be careful to protect the aluminium parts of the control panel from chemical compounds contained in the products used to clean the enamelled parts.

Removing the panels

Proceed as follows:

Unplug and remove the grill element;
Slide out roof panel and floor panel;
Unscrew the fixing ring nuts and remove the grille runners;
Lift the side panels off their support pins;
Remove the screws holding the back panel in position and lift it out.

Replacing the oven lightbulb

Disconnect the appliance from the electric supply.

Unscrew the lightbulb glass protection from the oven. Unscrew the lightbulb and replace it with a new bulb suitable for high temperature (300 °C) and having the following technical features:

Operating voltage: 240V- 50 Hz

Power absorbed: 15 W

Removing the oven door

(Fig. 7 A-B-C)

To thoroughly clean the oven you should remove the door by proceeding as follows:

1.

With the aid of a coin, turn the oven door stops (catches) a quarter of a turn (90°) to the right. See drawing A.

2.

Raise the door to the limit stop, press it lightly against the oven and pull it out in a forward direction. See drawing B. Grasp the door on the two sides- don't pull it by the handle. See drawing C.

To re-install the door:

1.

Insert the door into the oven with its two brackets.

2.

Open the oven door and return the door stops (catches) to their original position.

Figure 7

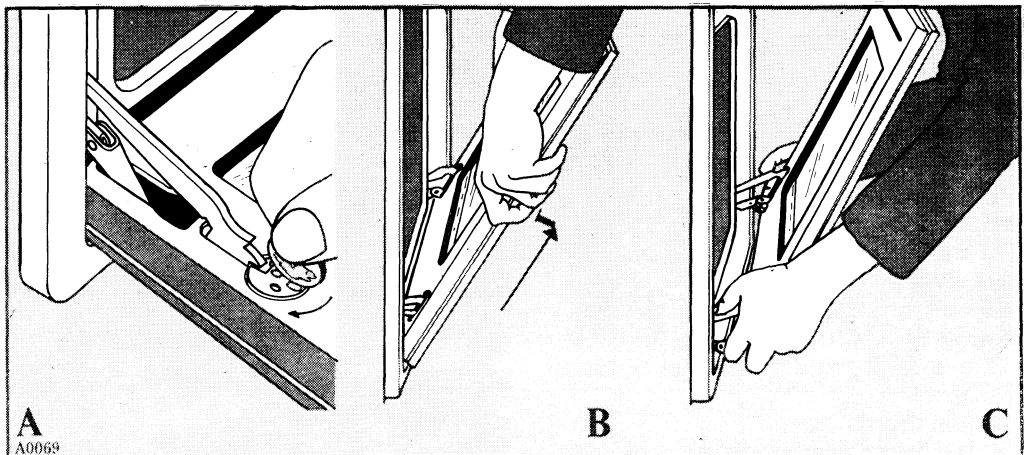

Instructions for the installer

Installation

The following instructions are meant for a qualified installer and should assist him in carrying out all installation, adjustment and maintenance operations in the most correct way and in accordance with existing laws and regulations.

Important: Before servicing the appliance or undertaking any maintenance work on it, be sure to disconnect it from the electric supply. Should it be absolutely necessary to keep the appliance 'live' take all possible precautions to prevent accidents.

Positioning

To ensure a troublefree operation of the appliance, it is a must that it be set up in a well ventilated kitchen (in this connection, the installer needs only comply with existing rules and regulations). The cooker may be positioned in such a way as to come into touch with the sides of the kitchen furniture. However, the latter must be able to withstand a temperature increase of 60 °C.

The appliance incorporates a removable base (A - Fig. 8/9) which permits the alignment with kitchen furniture having a height of 85 cm, plus levelling feet (B - Fig. 8).

To remove the metal base rest the appliance on a side, slide out the front plastic panel (C-Fig:8) which is push-fitted and then unscrew the six screws (D - Fig. 8) that secure the base to the cabinet.

Remove the levelling feet from the base (B - Fig. 8/9), screw them onto the cabinet and then fit the new front panel (optional) (E-Fig:9).

Position the appliance.

The appliance incorporates a set of

Figure 8

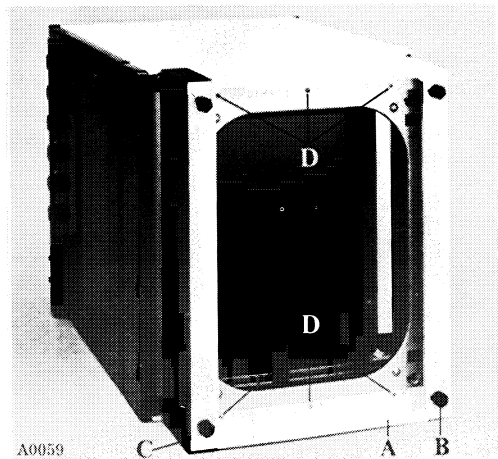

Figure 9

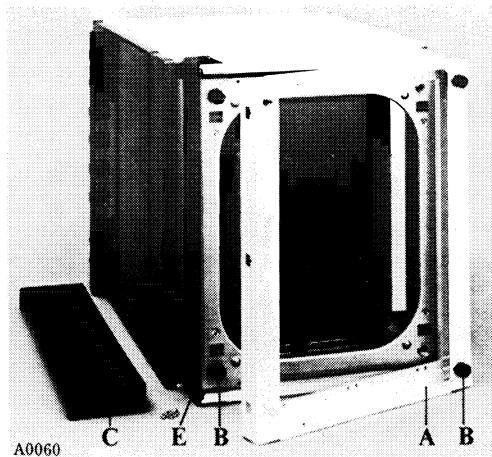
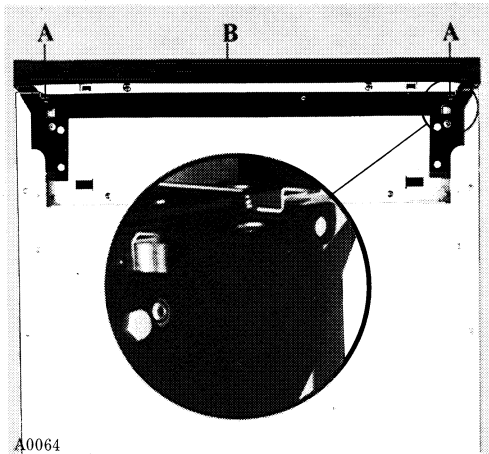

Figure 10



adjustable feet.

By properly adjusting the feet, the appliance can be set up at the required height and correctly aligned with the kitchen furniture or any other surface, thus ensuring an even spreading out of liquids in pans and pots:

These adjustable feet are easily accessible after removing the dish-warming drawer. To remove this drawer, proceed as follows:

pull out the drawer to the limit stop in order to slide out completely the side runners;

shift the front rollers up to the "buttonholes" of the side runners;

lift up the drawer and slide out the front rollers;

pull out the drawer and shift the rear rollers up to the "buttonholes" of the side runners;

lift up the drawer and slide out the rear rollers;

To replace the drawer, reverse the above procedure.

Alignment of the hob

(Fig. 10)

To allow the alignment with the kitchen unit, the hob is removable:

Loosen the two screws fixing the hob (A - Fig. 10);

Slide forward the hob (B - Fig. 10);

Block the hob by means of the screws;

Electrical connection

It is therefore advisable, the first time the appliance is used, to pre-heat the oven for about 30 mins. at peak temperature without putting any food into it.

The appliance is designed to operate on alternating current, with a single phase voltage of 240V - 50 Hz.

The electric supply cable has to be connected to the terminal board placed under the cover on the back of the appliance. The oven terminal board has the following markings:

L = Live N = Neutral $\frac{\perp}{\equiv}$ = Earth

The ground wire has to be green & yellow coloured. If you require a direct connection to the electric network (mains), it will be necessary to fit between the cooker and the mains an omnipole switch, with a minimum aperture between contacts of 3 mm, suitable to carry the required load and conforming to the ruling specifications. The green & yellow ground wire must not be interrupted by the switch.

The supply cable must at any rate be placed in such a way as to ensure that it does not reach at any given point a temperature 50 °C higher than the ambient temperature.

Prior to connecting the cooker to the electricity supply make sure that:

the protection fuse and the domestic wiring are suitable to carry the total electric load of the cooker (see rating plate):

the electricity supply network (mains) has an efficient earth connection according to the established rules and existing regulations;

with the cooker definitely installed, the wall socket or the omnipole switch can easily be reached.

The Manufacturer disclaims any liability in case these accident-preventing rules are not observed.

The heat insulation of the oven and grease residues from the manufacturing process produce smoke and an unpleasant smell during the first minutes of operation.

What happens if something goes wrong

Power cuts

Should the electricity supply fail for any reason remember to reset the electronic clock to the right time when the power is resumed.

If the cooker does not come on when cooking manually, first check that the programmer is set for manual, i.e. in the  position.

If this is as it should be and the oven still does not come on:

check that it is plugged in properly;
check that the socket switch and/or the switch from the supply to the oven are ON;
replace the fuse in the plug, when present, with another of the appropriate rating and check that this plug has been wired up properly;

check that the socket, when present, is supplying power-do this by plugging in another appliance that is known to be working properly;

check that the fuse in the fuse box is intact.

If, after all these checks, the oven still does not work, send for your local Zanussi network service centre listed in the telephone directory.

If helps to jot down the name and address and telephone number in the space below.

ZANUSSI GUARANTEE CONDITIONS

This guarantee is in addition to your statutory and other legal rights which will not be excluded or in any way diminished by the return of the enclosed card.

We, Zanussi Limited, guarantee that if within twelve months of the date of the purchase, this ZANUSSI appliance or any part thereof is proved to be defective by reason only of faulty workmanship or materials we will at our option repair or replace the same **FREE OF ANY CHARGE** for labour, materials or carriage on condition that:

- The appliance has been correctly installed and used only on the electricity supply stated on rating plate.
- The appliance has been used for normal domestic purposes and in accordance with the manufacturer's operating and maintenance instructions.
- The appliance has not been serviced, maintained, repaired, taken apart or tampered with by any person not authorised by us.

- The appliance is still in the possession of the original purchaser.
- Any appliance or defective part replaced shall become our property.

This guarantee does not cover any damage caused during transportation or the replacement of any light bulbs or removable parts of glass or plastic.

Should you require service on your Zanussi appliance consult the enclosed list for your nearest network centre. If the product is under first year guarantee then you will be required to produce proof of date of purchase to the engineer. If it is under 5 year cover then you must show your cover card to the engineer.

Please ensure that the enclosed pre-addressed card is stamped, completed in full and forwarded to Zanussi Limited, to enable the guarantee to be recorded. Also complete the space below as your own record of the guarantee.

GUARANTEE RECORD

Appliance purchased from _____ on _____
Guarantee card no _____ Model no _____
Serial no _____ (These details may be taken from your Guarantee Record Card)
Your name _____
Address _____

